

Multipratici

Synergie
ARREDARE IL BAGNO

INDEX

Comp.SMC-01	pag.006
Comp.SML-02	pag.014
Comp.SMC-03	pag.024
Comp.SML-04	pag.032
Comp.SMV-05	pag.042
Comp.SMC-06	pag.050
Comp.SMC-07	pag.058
Comp.SMC-08	pag.064
Comp.SMF-09	pag.070
Comp.SMC-10	pag.078
Comp.SMF-11	pag.084
Comp.SMC-12	pag.090
Comp.SMC-13	pag.098
Comp.SMZ-14	pag.106
Comp.SMC-15	pag.112
Comp.SMC-16	pag.116
Comp.SMC-17	pag.121
Comp.SMC-18	pag.123
Comp.SMC-19	pag.125
Comp.SMC-20	pag.129
Comp.SMC-21	pag.131
Comp.SMZ-22	pag.133
Comp.SMC-23	pag.137
Comp.SMC-24	pag.139
Comp.SMF-25	pag.141
Comp.SMC-26	pag.143







Qualità dei materiali, pregio delle finiture e cura dei dettagli, proiettano la nuova collezione di Synergie nel futuro dell'arredamento della stanza da bagno.

Quality material, prestigious finishes and attention to detail project the new Synergie collection into the future of bathroom furniture.

Qualité des matériaux, raffinement des finitions et soin des détails sont les maîtres mots de la nouvelle collection de Synergie, pour un agencement de salle de bains tourné vers le futur.



Il piano lavatoio 'Eko' con vasca integrata consente di realizzare soluzioni al centimetro, adatte a soddisfare le più svariate esigenze.

The 'Eko' laundry room vanity top with integrated sink can be made to measure to satisfy the most diverse needs.

Le plan lavoier 'Eko' avec vasque intégrée permet de réaliser des solutions sur mesure, pour répondre aux besoins les plus disparates.

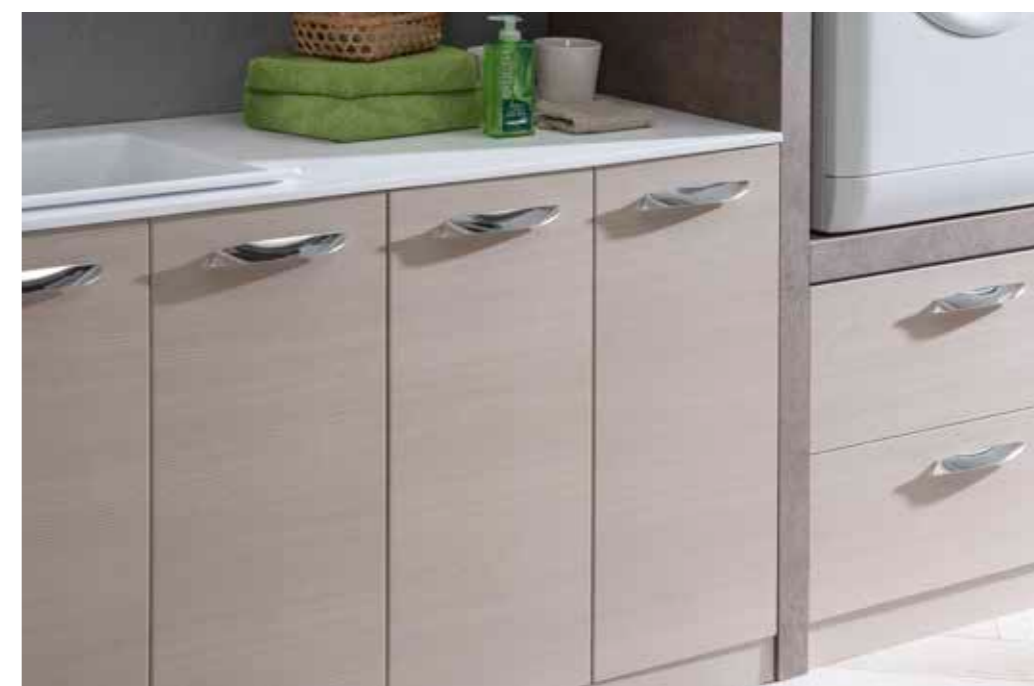
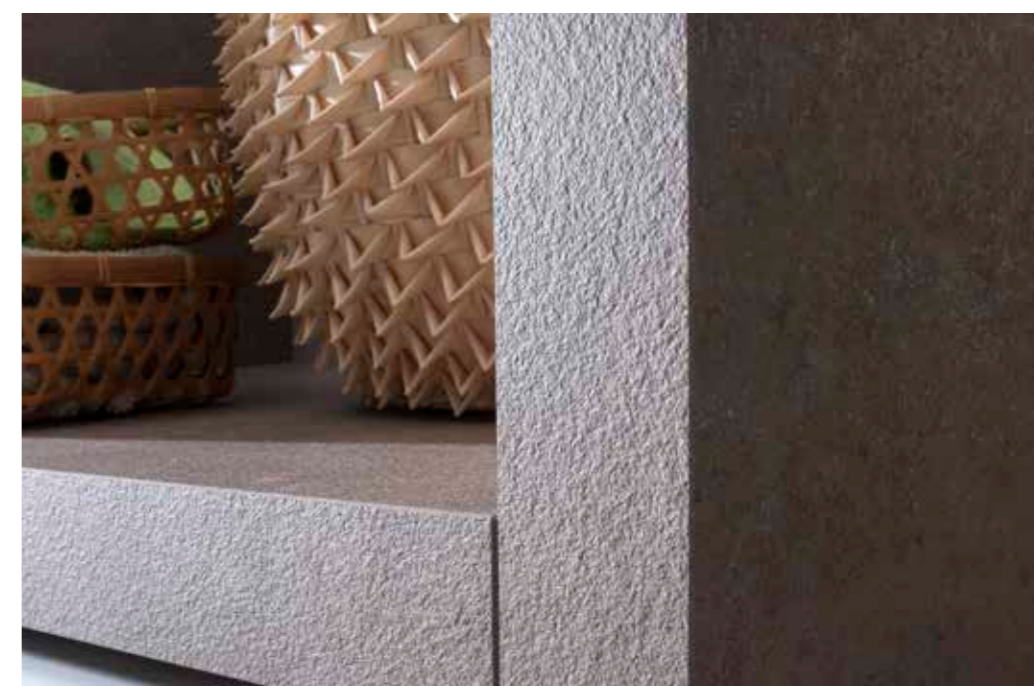



I particolari evidenziano il pensile a giorno in finitura venata, oltre a cassettoni attrezzati e cesti estraibili portabiancheria, che rendono il tutto ordinato e funzionale.

The details draw attention to the open unit with veined finish as well as the equipped deep drawers and pull-out laundry baskets that create a tidy and functional environment.

Les encadrés montrent le placard ouvert avec finition veines, les grands tiroirs aménagés et les paniers à linge coulissants qui permettent un rangement ordonné et fonctionnel.







La base a terra maggiorata in altezza consente di nascondere la lavatrice.

The washing machine can be hidden in the taller-sized cabinet.

Grâce à sa hauteur accrue, le meuble bas permet de dissimuler le lave-linge.

Grazie a soluzioni nascoste, 'Multipratici' trasforma ambienti di lavoro in ambienti eleganti.

Thanks to the hidden solutions, 'Multipratici' transforms work places into elegant environments.

Les meubles 'Multipratici' recèlent une foule de solutions astucieuses pour transformer les espaces de travail en ambiances élégantes.





Specchio 'Goccia' con illuminazione a led, pensili 'Aliseo' in metallo verniciato e lavatoio 'Eko' con asse nello stesso materiale, sono i punti salienti di questa composizione.

The 'Goccia' Mirror with led lighting, 'Aliseo' wall units in varnished metal and 'Eko' laundry room vanity top with washboard in the same material: these are the main features of this composition.

Le miroir 'Goccia' avec éclairage à led, les placards 'Aliseo' en métal laqué et le lavoire 'Eko' avec sa planche à laver réalisée dans le même matériau sont les points forts de cette composition.









La nuova struttura 'Unicolor' permette di inserire contenitori a discrezione della clientela.

The new 'Unicolor' structure means being able to insert containers based on the client's wishes.

La nouvelle structure 'Unicolor' permet d'insérer des rangements au gré de vos envies.





Le colonne nascondono cestelli estraibili per la biancheria, e il pratico asse da stiro reclinabile. Alla pagina successiva possiamo apprezzare l'illuminazione e la presa inserita nella colonna stiro.

The tall units hide pull-out laundry baskets and a practical, pull-down ironing board. The picture on the right shows the useful lighting and socket inside the tall unit with ironing board.

Les colonnes abritent discrètement des paniers à linge coulissants et une pratique table à repasser rabattable. La page suivante vous fait découvrir l'éclairage et la prise insérée dans la colonne de repassage.



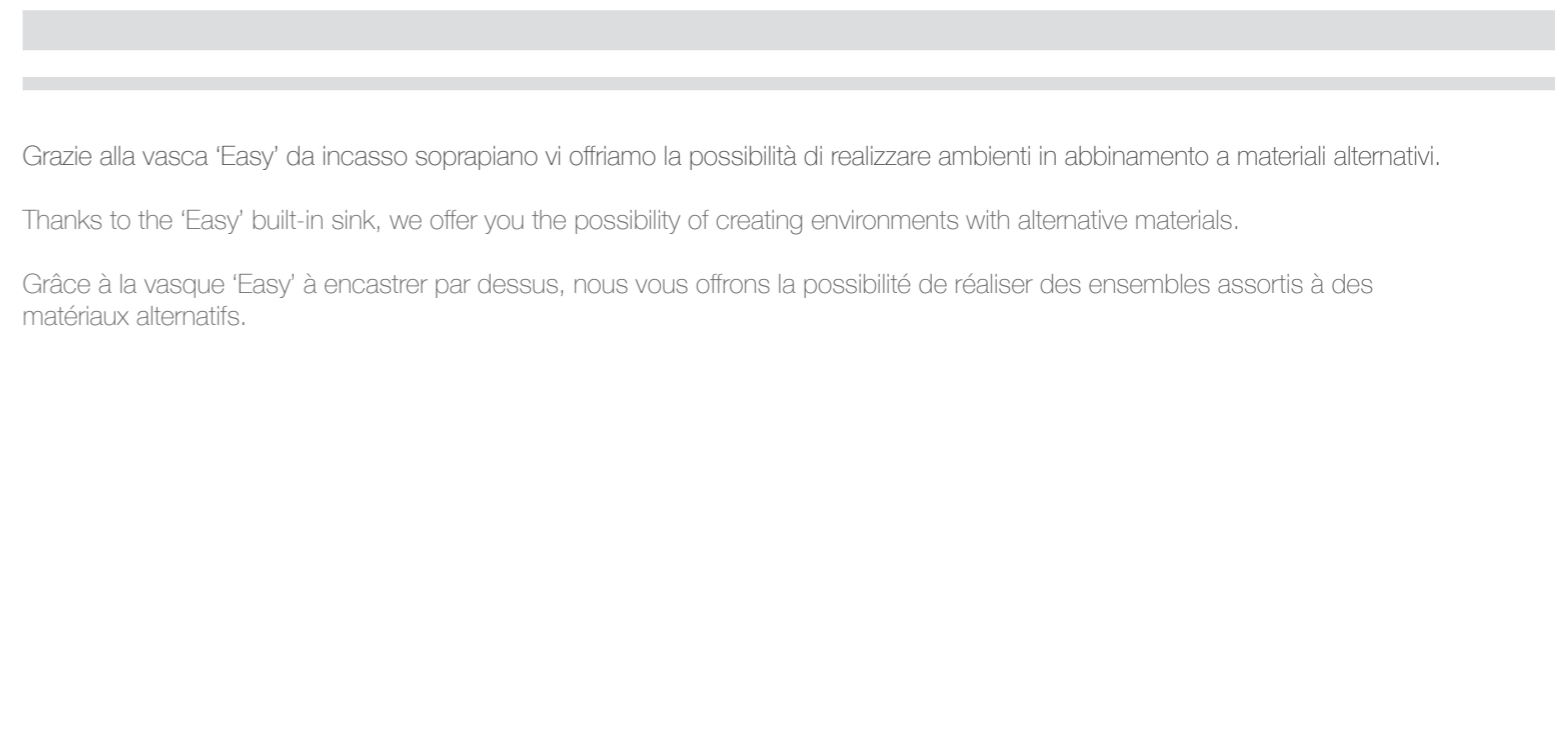

Grazie alla vasca 'Easy' da incasso soprapiano vi offriamo la possibilità di realizzare ambienti in abbinamento a materiali alternativi.

Thanks to the 'Easy' built-in sink, we offer you the possibility of creating environments with alternative materials.

Grâce à la vasque 'Easy' à encastrer par dessus, nous vous offrons la possibilité de réaliser des ensembles assortis à des matériaux alternatifs.

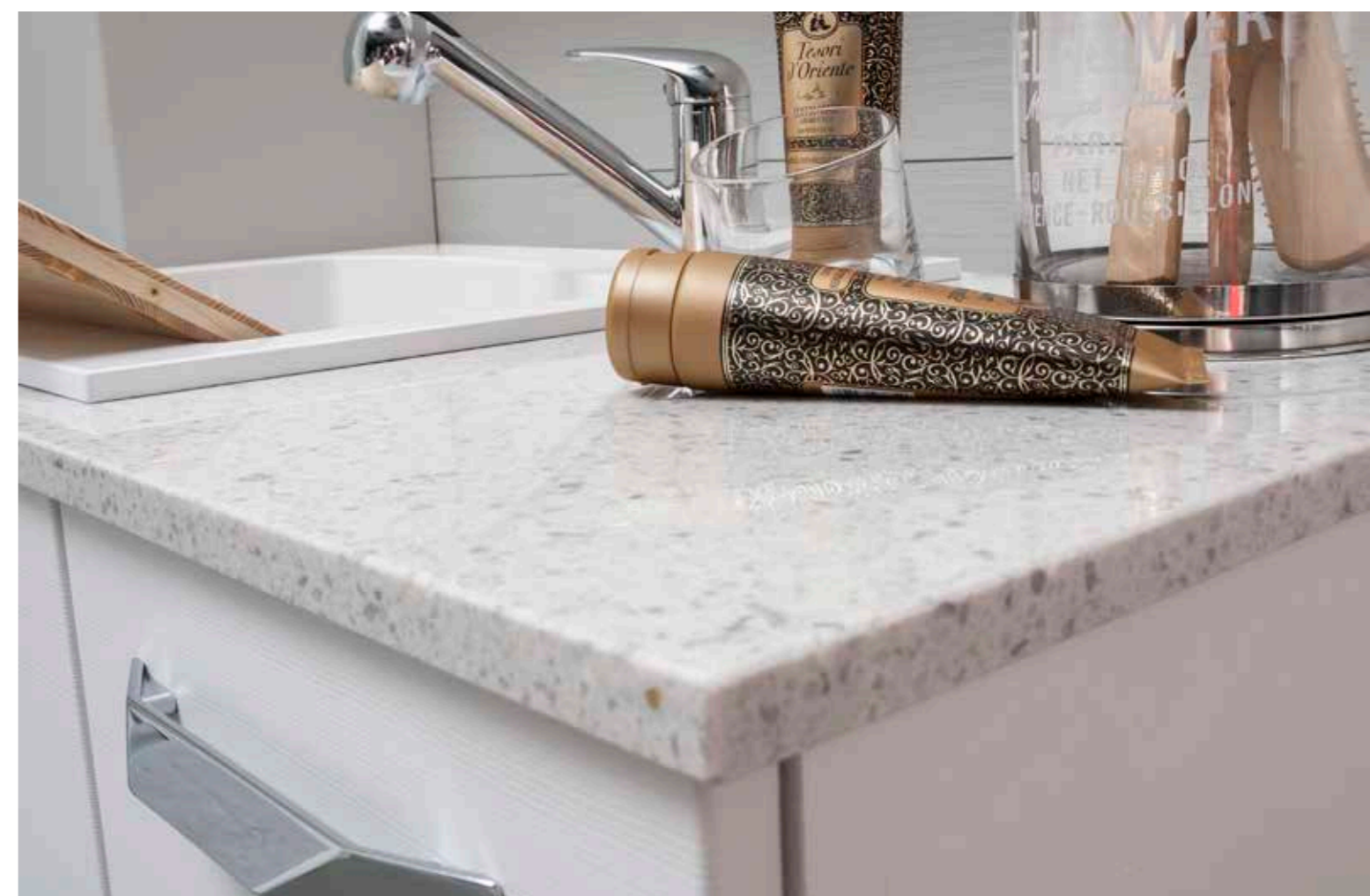





La pedana 'Unicolor' oltre a sorreggere la lavatrice, racchiude comodi cassettoni attrezzati.

The 'Unicolor' platform both supports the washing machine and includes handy, quipped deep drawers

La rehausse 'Unicolor' a la double fonction de supporter le lave-linge et d'accueillir des grands et pratiques tiroirs aménagés.





Nei particolari si può apprezzare l'effetto materico dell' Unicolor 'Luna' che in questa soluzione funge anche da piano lavoro per la vasca sopra piano 'Easy'.

The details show off the material effect of the 'Luna' Unicolor which, in this solution, is also the top that holds the 'Easy' overcounter sink.

Ces encadrés attirent l'attention sur le bel effet de la matière de l' Unicolor 'Luna' qui, dans cette solution, fait office également de plan de travail intégrant la vasque 'Easy' par le dessus.





Synergie propone ai suoi clienti un nuovo viaggio nell'arredamento del bagno, con proposte all'avanguardia e finiture di prestigio, grazie alla continua ricerca di elementi che garantiscono un scelta di valore.

Synergies offers its clients a new journey into bathroom furniture with cutting-edge proposals and prestigious finishes thanks to constant research for elements that guarantee valuable choices.

Synergie vous offre une nouvelle approche de l'agencement de salles de bains avec ses propositions avant-gardistes et finitions prestigieuses, grâce à la continuelle recherche d'éléments qui apportent d'emblée une réelle valeur ajoutée.

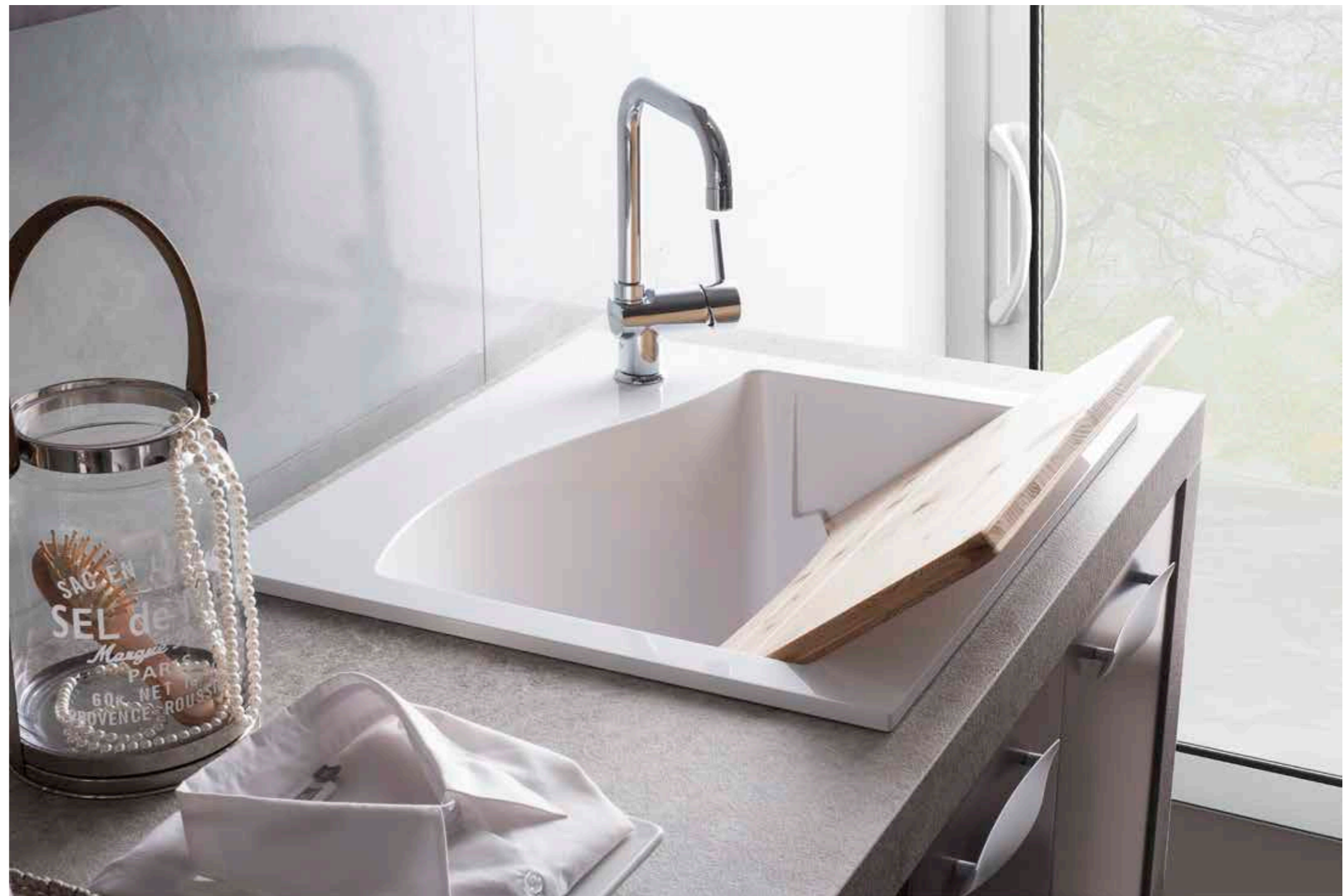







Un bel dettaglio della finitura Laccato Opaco su Venato

A nice detail of the finish of Matt Lacquer on grained

Un joli détail de la finition de vernis mat sur veiné

La base lavatrice si presta a sostenere un pratico fasciatoio, che in fase di riposo possiamo riporre nella base a giorno.

The washing machine unit also functions as a practical changing table; the pad can be put in the open space of the unit when not being used.

Le meuble lave-linge se prête parfaitement à accueillir un pratique matelas à langer, qui trouve sa place dans une niche quand il ne sert plus.



In alternativa la base stessa può essere attrezzata con comodi portasciugamano estraibile

Alternatively, the open space of the unit can be equipped with handy, pull-out towel racks.

En alternative, ce meuble peut être équipé de pratiques porte-serviettes escamotables.





Specchio e pensili 'Ameba' arricchiscono la scena dove il lavatoio monoblocco sospeso 'Easy' fa da protagonista.

'Ameba' mirror and wall unit enrich the room where the suspended 'Easy' laundry room vanity top is protagonist.

Le miroir et les placards 'Ameba' viennent enrichir la scène où le lavoire suspendu 'Easy', réalisé d'un seul tenant, joue un rôle de protagoniste.





Le pratiche colonne e le serrandine con ripiani sagomati mantengono l'ordine, arredando elegantemente i diversi spazi della casa.

The practical tall units and the units with rolling shutter and shaped shelves keep the room tidy while elegantly furnishing the different spaces of the home.

Les pratiques colonnes avec rideaux coulissants et tablettes offrent des rangements bien pensés tout en apportant une touche d'élégance aux différents espaces de la maison.



La cura nei dettagli e ricercatezza delle finiture dei 'Multipratici' si presta a soddisfare la clientela alla ricerca di funzionalità, senza dover rinunciare all'arredo di buon gusto.

Attention to the detail and the components of the 'Multipratici' finishes satisfies the client's search for functionality as well as elegant furnishings.

Le soin des détails et le raffinement des finitions des meubles 'Multipratici' sont les facteurs clés pour satisfaire une clientèle à la recherche de fonctionnalité sans devoir renoncer au bon goût.







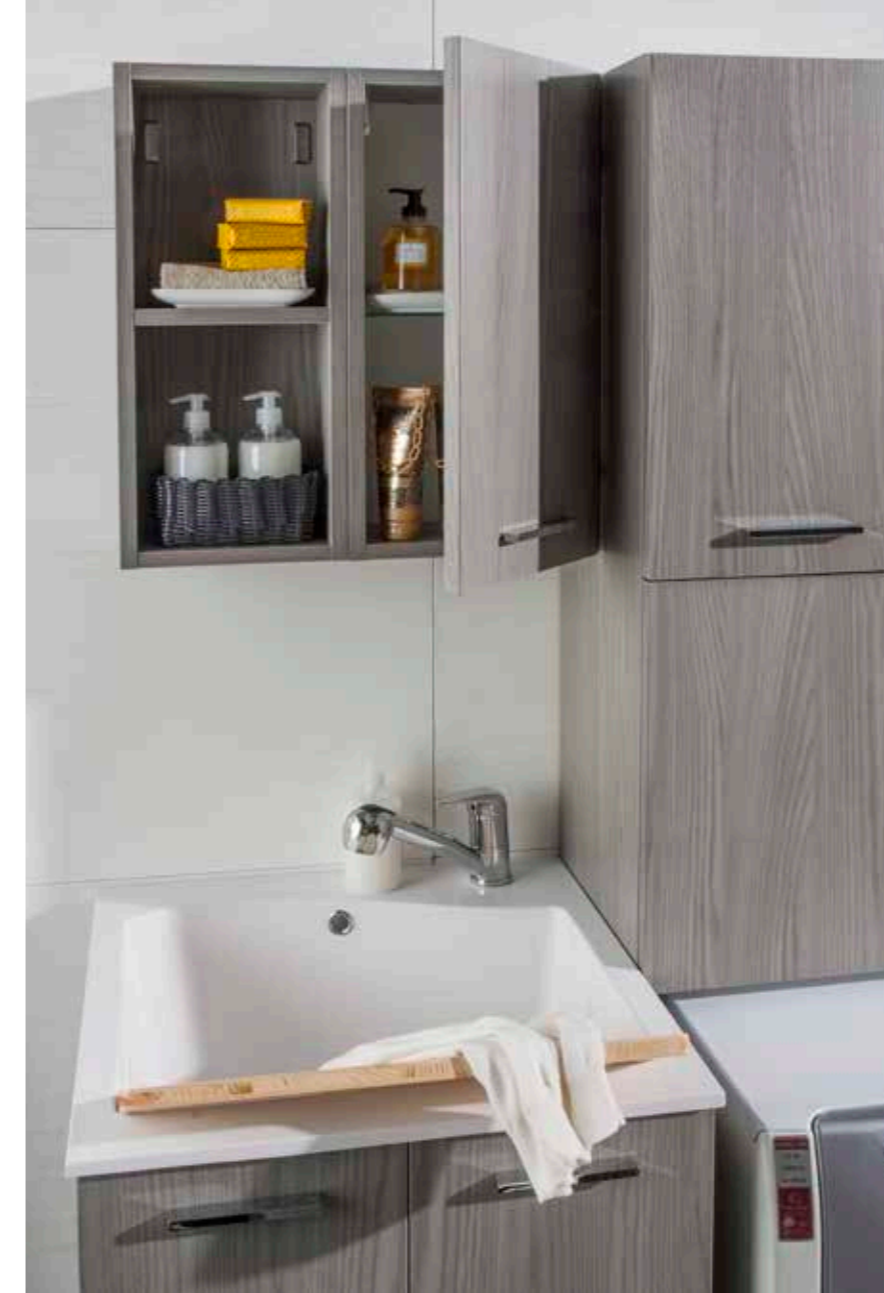

Composizione presentata nella nuova finitura 'Greystone'. Al centro della colonna, l'anta a ribalta con il cesto portabiancheria cromato, consente di avere tutto il necessario a portata di mano.

This composition is in the new 'Greystone' finish. At the centre of the tall unit, the pull-down door with the chrome-plated laundry basket puts everything you need at your fingertips.

Composition présentée avec la nouvelle finition 'Greystone'. Au centre de la colonne, une porte abattante avec panier à linge chromé apporte le maximum de praticité.

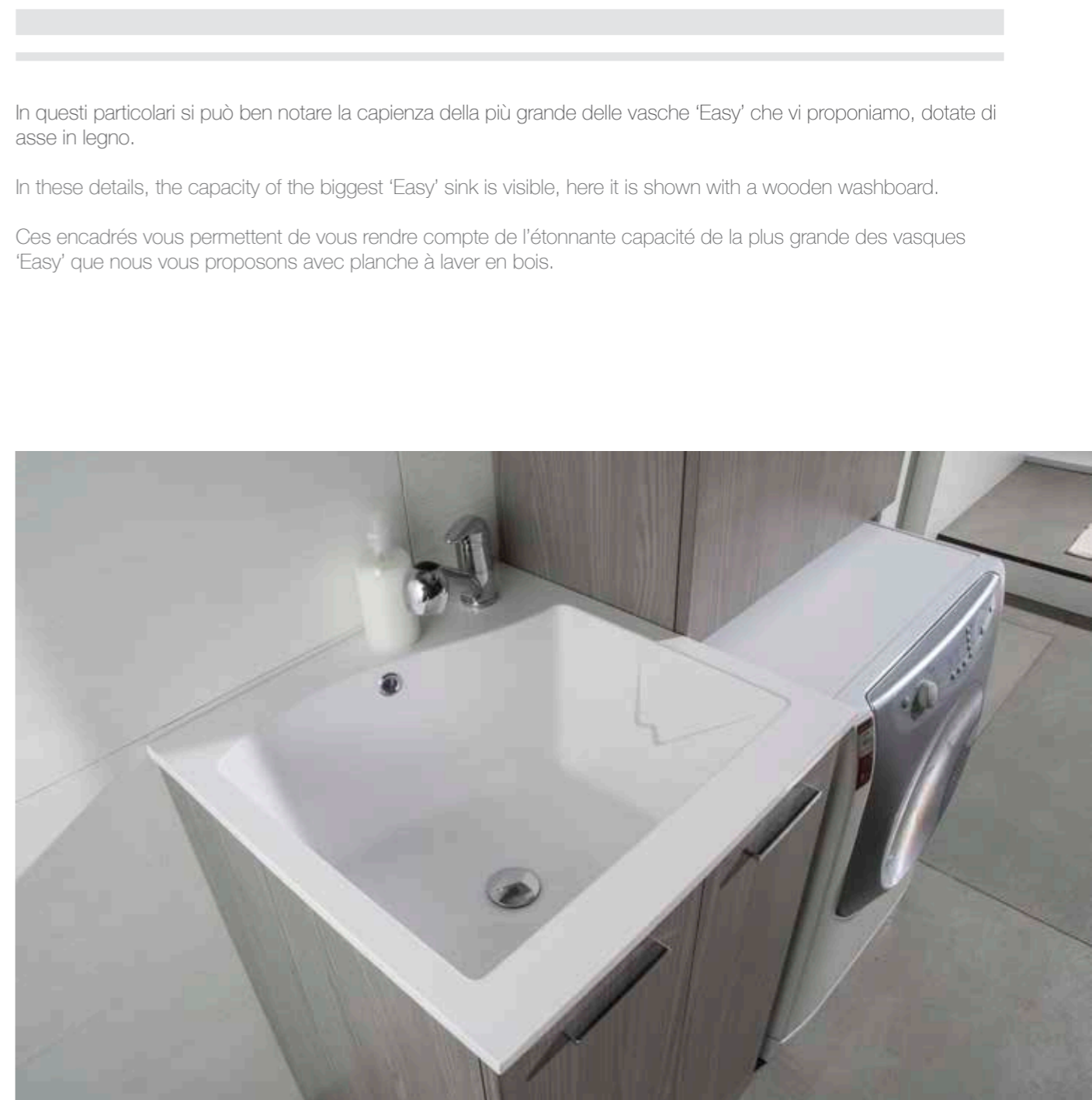

In questi particolari si può ben notare la capienza della più grande delle vasche 'Easy' che vi proponiamo, dotate di asse in legno.

In these details, the capacity of the biggest 'Easy' sink is visible, here it is shown with a wooden washboard.

Ces encadrés vous permettent de vous rendre compte de l'étonnante capacité de la plus grande des vasques 'Easy' que nous vous proposons avec planche à laver en bois.





Varie larghezze altezze e profondità delle scarpere consentono di sfruttare spazi diversi del vostro ambiente.

Various widths, heights and depths of the shoe rack unit allow you take advantage of the different spaces in your house.

Des range-chaussures de différentes largeurs, hauteurs et profondeurs trouvent leur place partout.

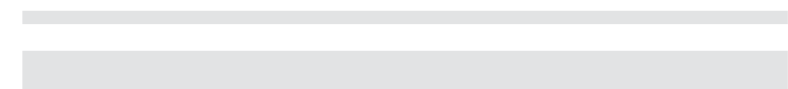

La colonna portabiancheria racchiude in soli 35 cm di profondità il vano a giorno per la lavatrice a vista, il cesto a ribalta per la biancheria, e lo spazio contenitivo superiore.

The tall unit for linen, only 35 cm deep, includes an open space for the washing machine in view, the pull-down laundry basket and an upper storage space.

Avec seulement 35 cm de profondeur, la colonne à linge comprend un logement ouvert pour le lave-linge, un panier à linge abattant et un rangement en partie haute.







Pratici vani a giorno e capienti cassettoni attrezzati a chiusura rallentata sono i punti salienti di questa composizione.

Practical open spaces and spacious, equipped deep drawers with slow motion closure are the highlights of this composition.

Les pratiques placards ouverts et les grands tiroirs aménagés à fermeture ralentie sont les points forts de cette composition.

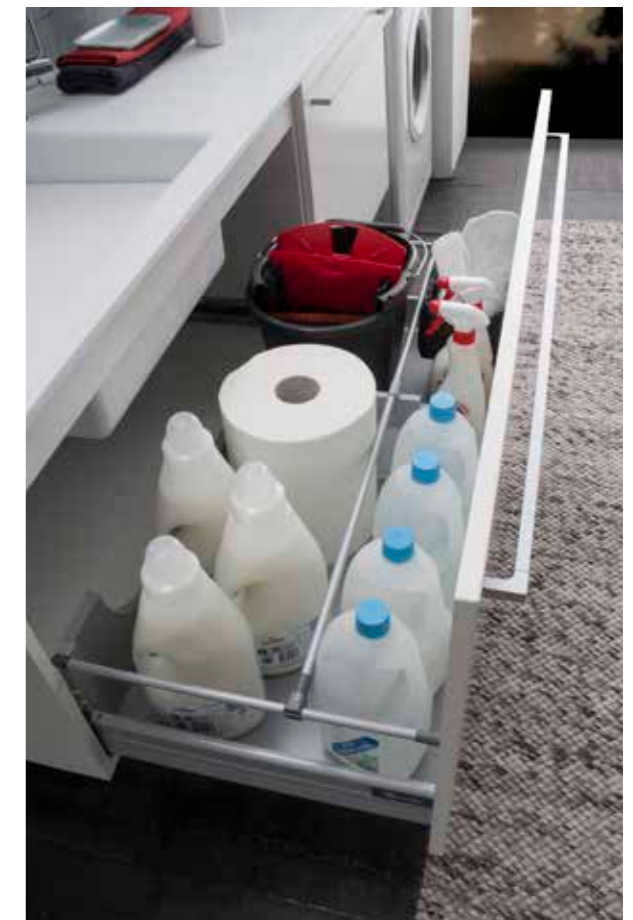



Lo specchio 'Goccia' con retroilluminazione a led arricchisce l'ambiente contribuendo a cambiare il concetto di lavanderia, non più limitato a semplice luogo di lavoro, ma ora concepito anche come zona elegante e di design.

The 'Goccia' mirror with back, led lighting enriches the room by changing the concept of laundry room; not only a workspace, but now designed as an elegant environment.

Le miroir 'Goccia' avec éclairage arrière à led enrichit l'environnement en contribuant à faire évoluer le concept de buanderie, qui ne se limite plus à être un simple lieu de travail mais qui devient à présent un élégant espace design.





Il particolare evidenzia la capacità contenitiva della colonna lavatrice. Nella pagina accanto l'asse in tecnorit del piano lavatoio 'Eko', riposto nel suo vano all'interno della vasca, trasforma la stessa da capiente lavatoio a moderno lavabo.

The highlight of this composition is the spaciousness of the washing machine tall unit. In the photo on the right, the tecnorit washboard of the 'Eko' laundry room vanity top placed in its space in the sink, transforms the vanity from a simple wash space to a modern sink.

L'encadré met en évidence la surprenante capacité de rangement de la colonne lave-linge. Sur la page ci-contre, la planche à laver en Tecnorit du plan lavoir 'Eko' positionnée dans la vasque, transforme le lavoir à haute capacité en vasque moderne.

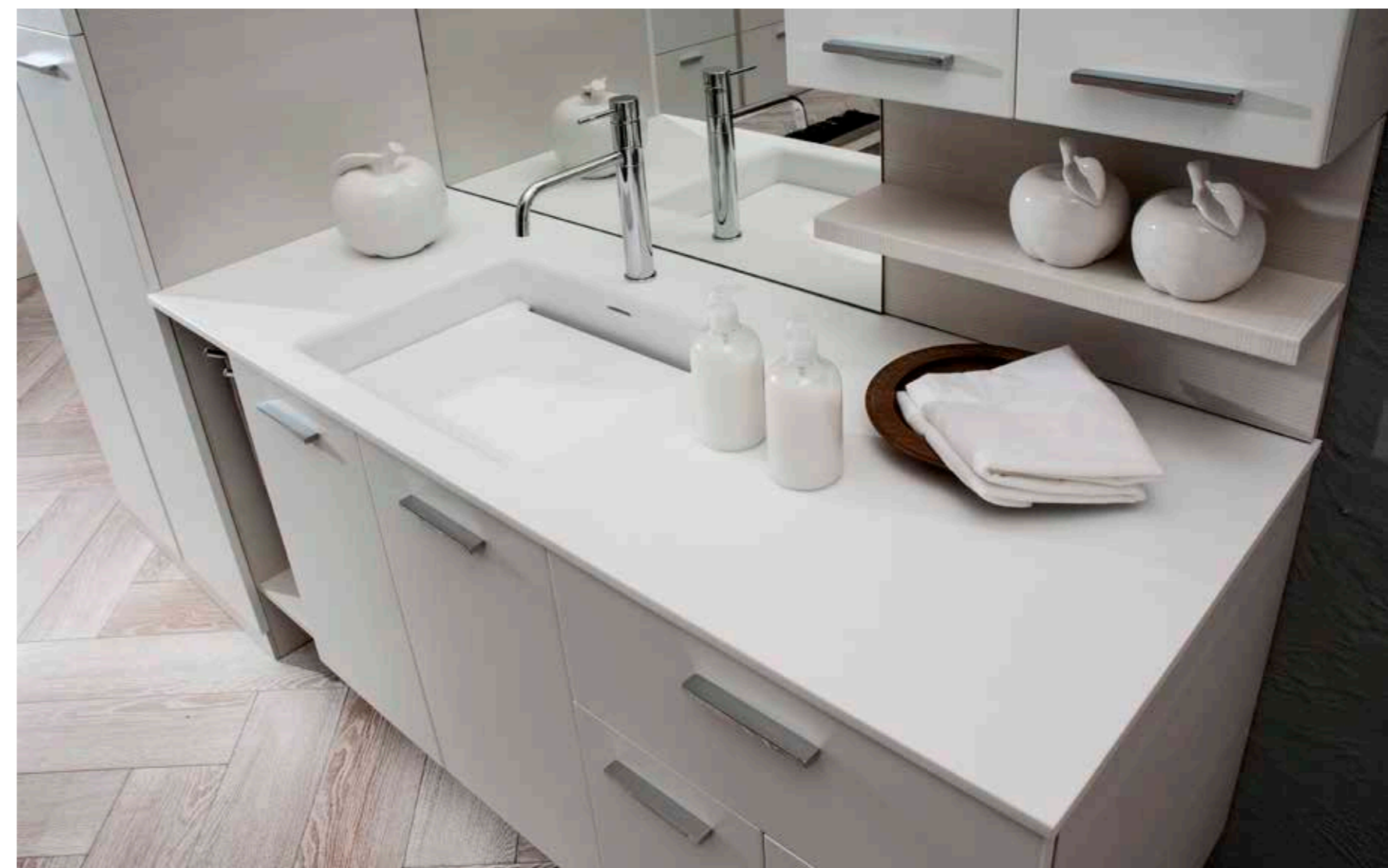

Da una scelta accurata di articoli risulta un'unica composizione che racchiude in se gli elementi fondamentali sia della zona lavanderia che dell'ambiente bagno.

From the careful choice of items, this composition is unique and includes in it the fundamental elements of the laundry room as well as the bathroom.

Un choix méticuleux d'articles a donné naissance à cette composition unique qui renferme en soi les éléments fondamentaux de la zone buanderie tout comme de l'espace bains.





Lo specchio 'Krabl' raddoppia, con una nuova versione H.62,4 dotata di vano a giorno.

The 'Krabl' mirror increases in size with a new 62,4 cm high version with an open space.

Le miroir 'Krabl' redouble, avec une nouvelle version H. 62,4, dotée d'un espace de rangement ouvert.

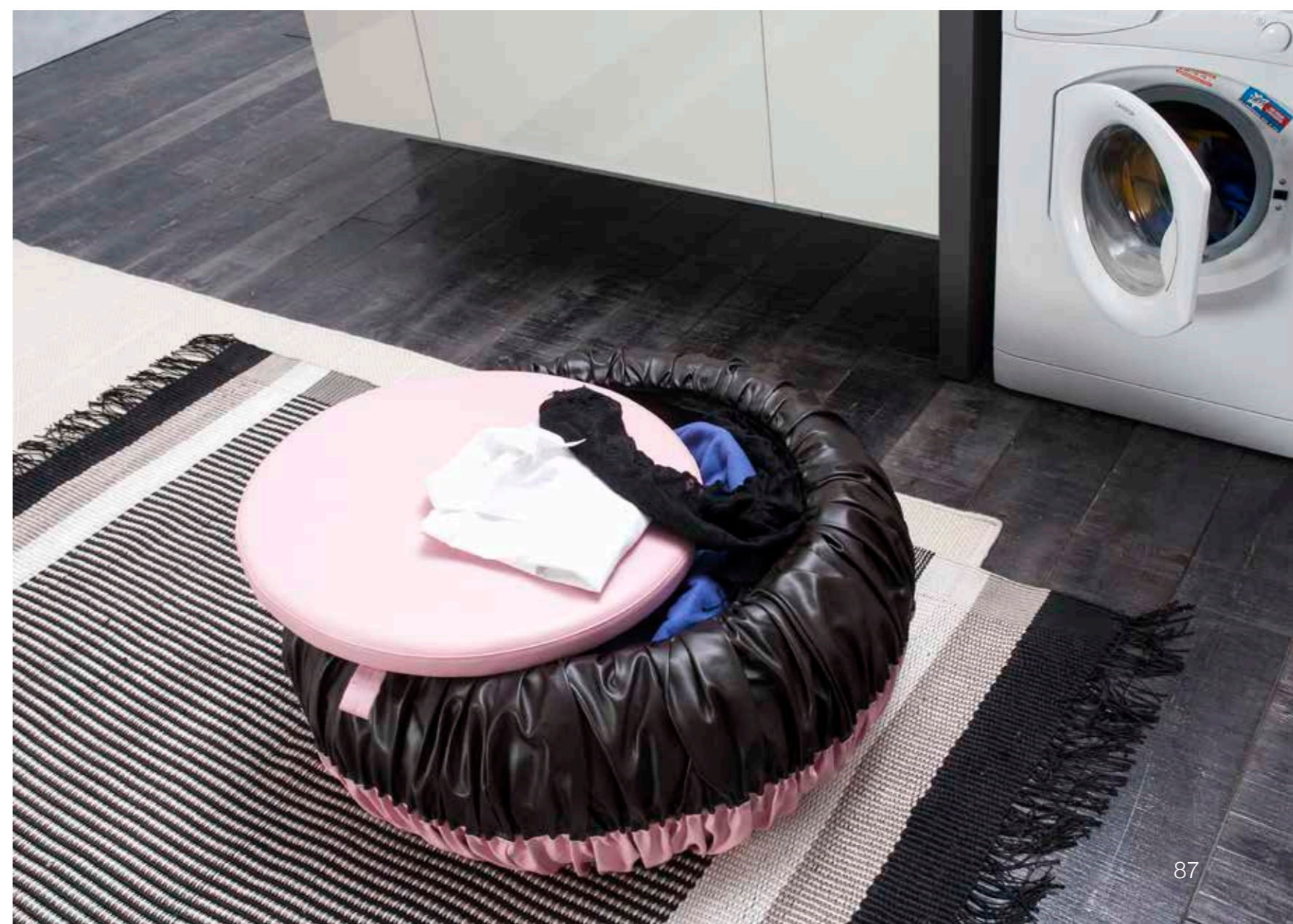
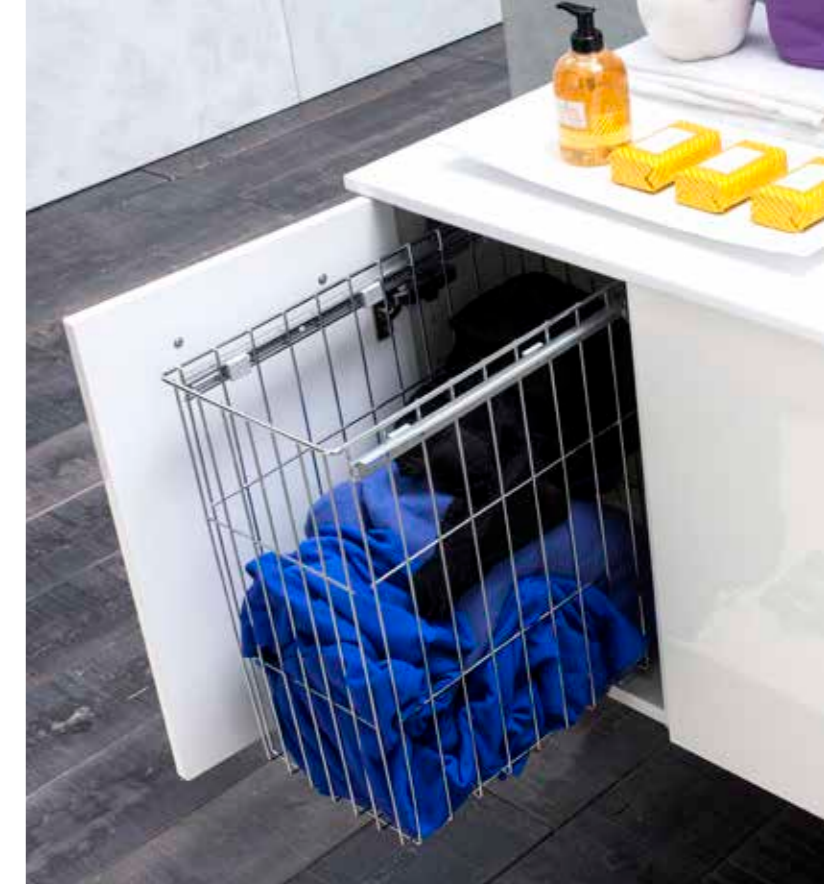

Il programma 'Unicolor' permette di ottimizzare gli spazi, inserendo nella struttura lavatrice e asciugatrice sovrapposte.

The 'Unicolor' programme allows you to optimize the available space by inserting the washing machine and dryer one above the other.

Le programme 'Unicolor' vise à optimiser les espaces en permettant de superposer le lave-linge et le sèche-linge l'un sur l'autre dans la même structure.





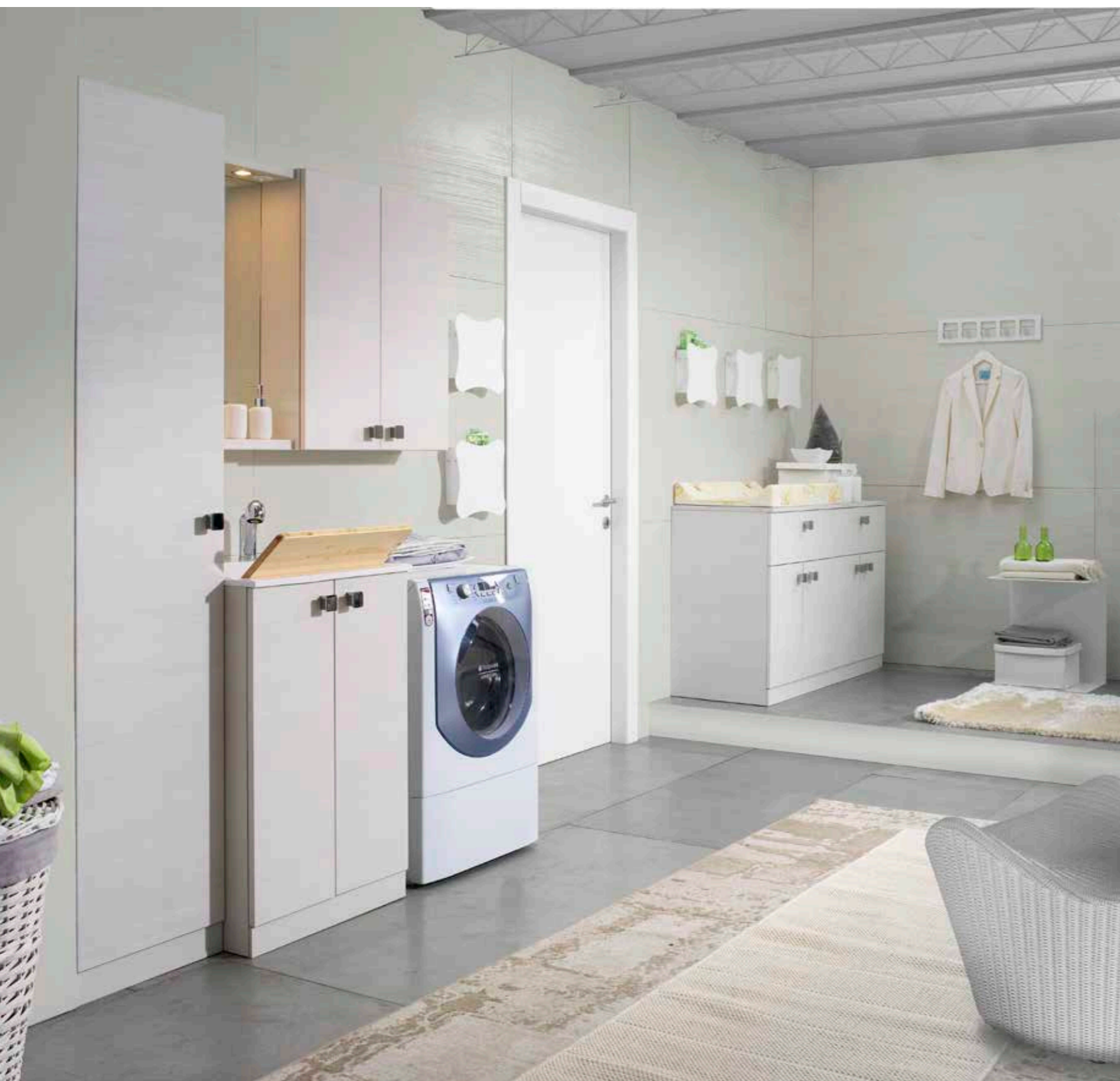

I pensili 'Aiseo' con la particolare apertura a ribalta custodiscono oggetti essenziali d'uso quotidiano.
The 'Aiseo' wall units with the pull-down opening safeguards the important objects we use every day.
Les placards 'Aiseo' avec leur porte relevable particulière accueillent tous les objets d'usage quotidien.





Nel particolare si nota l'articolo portascoppe che caratterizza la colonna attrezzata.

In the detail, the broom "holder" that characterizes the equipped tall unit.

L'encadré montre le porte-balais qui caractérise cette colonne aménagée.







Semplicemente togliendo l'asse in materiale tecnico, e posizionandolo sugli appositi rientri, il bagno si trasforma in zona lavanderia con capiente vasca lavapanni.

Just by taking away the washboard in technical material and placing it in the special spaces, the bathroom is transformed into a laundry room with spacious sink to wash clothes.

En retirant simplement la planche à laver en matériau technique et en la positionnant dans les relatifs encastrements, la salle de bains se transforme en une zone buanderie dotée d'une grande vasque pour le lavage à la main.







I pratici pomoli 'Zen' si abbinano perfettamente alla nuova finitura 'Greystone'.

The practical 'Zen' knobs combine perfectly with the new 'Greystone' finish.

Les pratiques poignées 'Zen' sont en parfait accord avec la nouvelle finition 'Greystone'.



La particolare apertura a vela dello specchio 'Zippo' è resa possibile dal nuovo meccanismo privo di pistoni. Risulta un funzionamento agevole e garantito nel tempo.

The particular up and over opening of the 'Zippo' mirror is possible thanks to the new mechanism without pistons. The opening is thus easy and guaranteed in time.

La particulière ouverture relevante du miroir 'Zippo' est réalisée par le nouveau mécanisme dépourvu de vérins. Il en résulte un fonctionnement aisé et garanti au fil du temps.



..... IF YOU
CAN'T STAY
TAKE ME
AWAY →

Monday

SPECIALS

12:00 pm cleaning class
12:30 pm make out your Billie
1:00 pm bring the
1:30 pm go to yoga class
10:00 pm Goodnight



Composizione moderna, laccata lucida, dotata di vani a giorno e cesti contenitivi per la biancheria, illuminazione a led e piano lavatoio 'Eko' con vasca integrata, nascosta elegantemente dall'asse in teknorit.

Glossy lacquered, modern composition with open spaces and laundry baskets, led lighting and 'Eko' laundry room vanity top with integrated sink, elegantly hidden by the teknorit washing board.

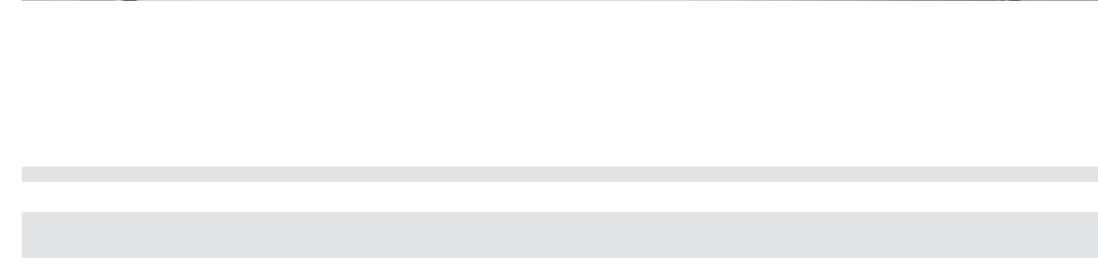

Composition moderne laquée brillant, dotée de rangements ouverts, paniers à linge, éclairage à led et plan lavoir 'Eko' avec vasque intégrée, dissimulée élégamment par la planche à laver en Teknorit.



Lavatrice e asciugatrice poggiano sulla pedana 'Unicolor' che permette il vano per pratici cassettoni attrezzati. Sopra, i pensili con apertura a rialza, offrono un valido spazio per l'alloggiamento degli accessori di uso quotidiano.

The washing machine and dryer are installed on the 'Unicolor' platform with equipped, deep drawers. Above, the wall units with pull up doors have the storage space for every day accessories.

La machine à laver et sèche-linge sont installés sur la plate-forme 'Unicolor' avec équipés, tiroirs profonds. Ci-dessus, les unités de mur avec tirer vers le haut des portes disposent de l'espace de stockage pour tous les accessoires de jours.



Comp. SMC-15





I particolari evidenziano la capiente colonna attrezzata portascoppe, oltre alla nuova finitura 'Swedish Cotton', nonché la vasca incasso soprapiano 'Easy'.

The details show the spacious equipped tall unit for brooms as well as the new 'Swedish Cotton' finish and the 'Easy' built-in sink.

Les encadrés montrent la colonne à grande capacité de rangement, équipée de porte-balais, la nouvelle finition 'Swedish Cotton', ainsi que la vasque 'Easy' encastrée par dessus.





- 1 scarpiera 3 ante ribalta
- 2 colonna attrezzata - stiro
- 3 contenitore multiuso a serrandina
- 4 colonna attrezzata - portabiancheria con vano lavatrice
- 5 colonna attrezzata - portascope
- 6 colonna attrezzata - cesti portabiancheria
- 7 specchio sospeso con faretti alogeni e presa interruttore
- 8 piano lavatoio 'Eko' con vasca integrata

- 1 shoe rack unit with 3 pull-down doors
- 2 equipped, 'ironing' tall unit
- 3 unit with rolling shutter
- 4 equipped tall unit - laundry basket with open space for washing machine
- 5 equipped tall unit - broom closet
- 6 equipped tall unit - laundry baskets
- 7 suspended mirror with halogen spotlights and plug
- 8 'Eko' laundry room vanity top with integrated sink



- 1 range-chaussures 3 abattants
- 2 colonne aménagée - repassage
- 3 armoire multifonction à rideau coulissant
- 4 colonne aménagée - pour le rangement du linge et logement pour lave-linge
- 5 colonne aménagée - porte-balais
- 6 colonne aménagée - paniers à linge
- 7 miroir suspendu avec spots halogènes et boîtier avec prise et interrupteur
- 8 plan lavoir 'Eko' avec vasque intégrée





La particolare apertura a libro consente di usufruire comodamente delle colonne porta abiti idonee per arredare vari spazi della casa.

The special bi-fold doors allow you take advantage of the space of the "wardrobe" tall units suitable for furnishing different areas of the house.

Grâce aux portes pliantes, les colonnes penderies offrent un gain de place et s'adaptent aisément à tous les espaces de la maison.

Il programma 'Multipratici' propone cassettoni su cui poggiano pannelli attrezzati con appendini, piuttosto che pannelli con mensole e specchio.

The 'Multipratici' programme proposes deep drawers with equipped panels with clothes hooks or panels with shelves and mirror.

Le programme 'Multipratici' propose des grands tiroirs sur lesquels viennent se poser des panneaux de fond équipés de patères ou d'étagères et de miroir.



Sia esso un ingresso, antibagno, o lavanderia, il vasto programma 'Multipratici' si adatta per arredare ogni zona di disimpegno.

Be it an entrance, a bath ante-room or laundry room, the ample 'Multipratici' programme adapts to every hallway area.

Que ce soit pour meubler une entrée, un vestibule ou un coin buanderie, le vaste programme 'Multipratici' s'adapte à l'espace que vous lui réservez.

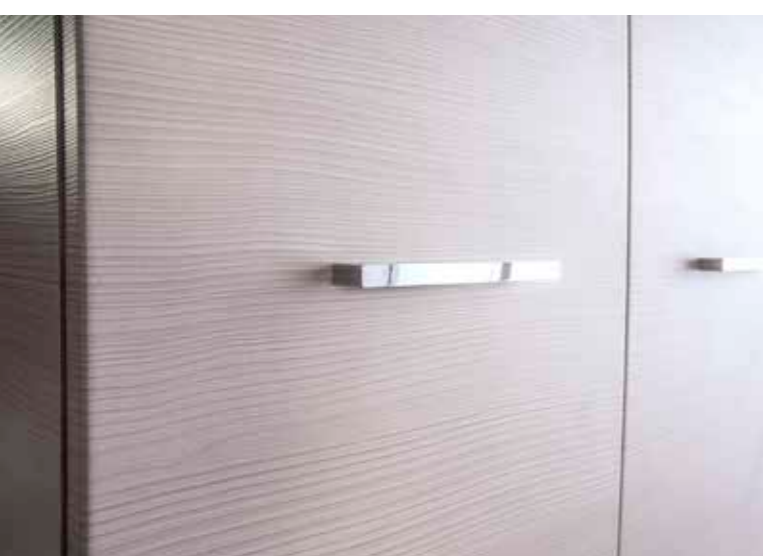





Il programma 'Unicolor' si presta con stile ed eleganza a riempire gli spazi, abbinandosi perfettamente a cassettoni e vani a giorno.

The 'Unicolor' programme stylishly and elegantly furnishes the spaces of the house by combining perfectly with deep drawers and open spaces.

Le programme 'Unicolor' se prête avec style et élégance à remplir les espaces en s'accordant parfaitement avec les grands tiroirs et les rangements ouverts.





Composizione semplice, ma ricercata al tempo stesso, dove appendini, specchi, mensole e cassettoni attrezzati si fondono in un mix di funzionalità.

A simple composition that is elegant at the same time; clothes hooks, mirrors, shelves and equipped deep drawers come together for a functional mix of elements.

Composition à la fois simple et recherchée, où les patères, les miroirs, les étagères et les grands tiroirs aménagés s'allient pour atteindre le summum de la fonctionnalité.





Vani a giorno, specchio 'Stream' e pensili contenitivi 'Aliseo', per un mix di praticità ed eleganza.

Open spaces, the 'Stream' mirror and the 'Aliseo' wall unit come together for a practical and elegant mix .

Rangements ouverts, miroir 'Stream' et placards 'Aliseo', des éléments bien pensés qui unissent praticité et d'élégance.







'Unicolor' si adatta a diventare piano di lavoro che con 'Multipratici' possiamo destinare a vari ambienti. Gli specchi 'Ameba' completano l'arredamento.

'Unicolor' becomes a worktop which, with 'Multipratici', can be installed in different rooms. The 'Ameba' mirrors complete the furniture.

'Unicolor' oublie sa fonction première pour devenir un plan de travail qui peut être destiné, grâce à 'Multipratici', à différents espaces. Les miroirs 'Ameba' complètent l'agencement.



Sui cassettoni attrezzati spicca la maniglia 'Step' che caratterizza il mobile. L'insieme di pensili, specchi e pannelli 'Ameba' con appendini si adattano ad ogni situazione.

The 'Step' handle, which characterizes the element, stands out on the equipped deep drawers. The combination of 'Ameba' shelves, mirrors and panels with clothes hooks adapt to every situation.

Les poignées 'Step' viennent rythmer les grands tiroirs aménagés et apportent aux meubles tout leur cachet. L'ensemble de placards, miroirs et panneaux de fond "Ameba", équipés de patères, s'adapte parfaitement à tous cas de figure.



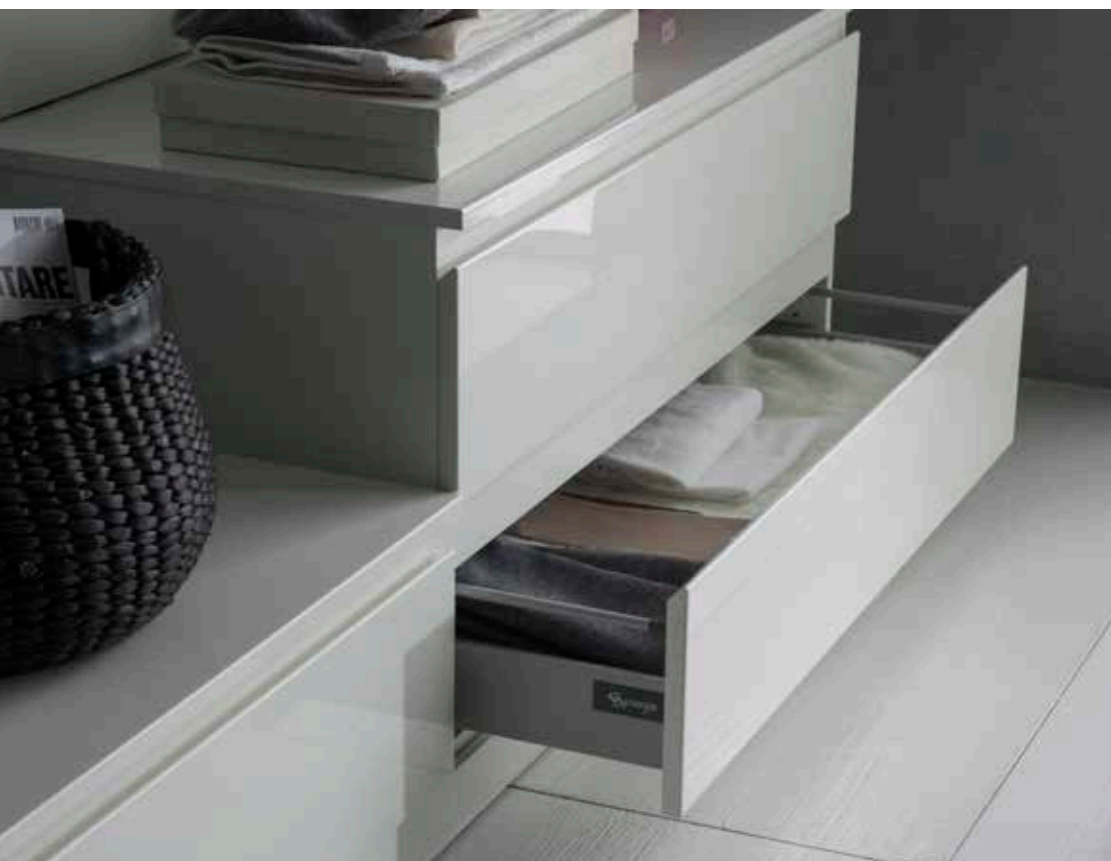

Particolare del cassettone con maniglia 'Include', sul quale poggia il pannello attrezzato con appendini e specchio orizzontale.

Above a detail of the deep drawer with 'Include' handle on which the equipped panel with clothes hooks and horizontal mirror is installed.

Détail du grand tiroir avec poignée 'Include', sur lequel vient se poser le panneau de fond équipé de patères et miroir horizontal.

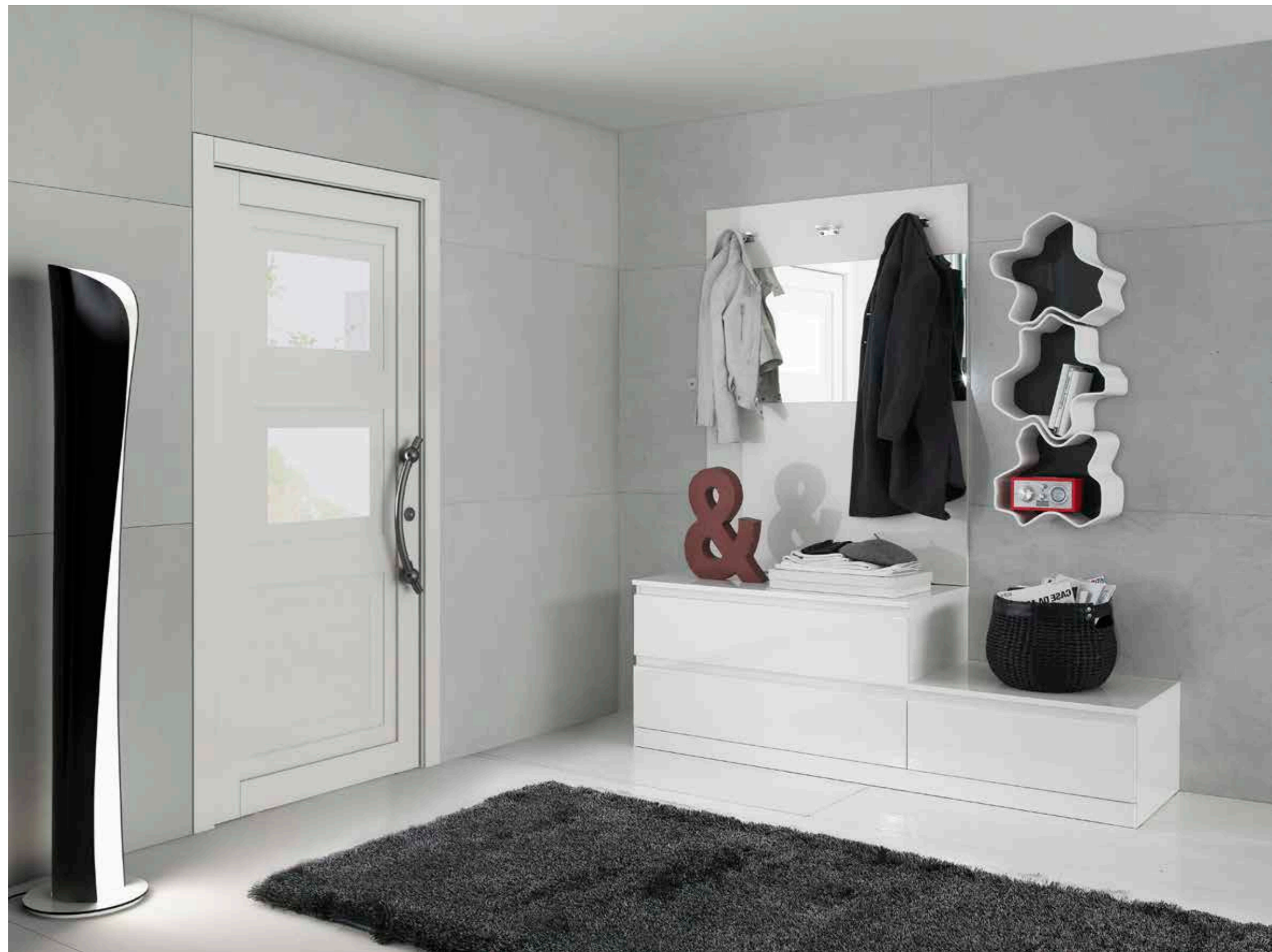

Scarpiera in profondità 17 in finitura 'Swedish Cotton' e pannelli colorati 'Ameba' con appendini, riempiono gli spazi.

17 cm-deep shoe rack unit with the 'Swedish Cotton' finish and the 'Ameba' coloured panels with clothes hooks fill the different space of the house.

Les range-chaussures profondeur 17 avec finition 'Swedish Cotton' et les panneaux de fond colorés 'Ameba' équipés de patères remplissent les espaces.





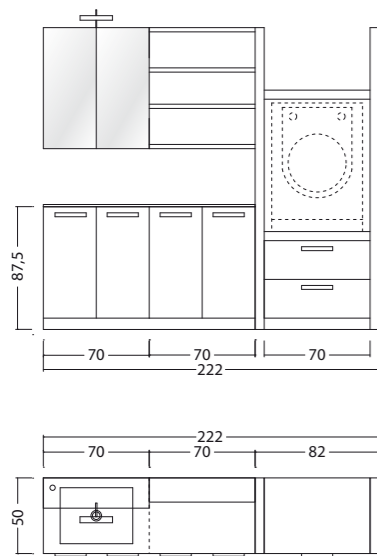

Comp. SMC-01 - pag. 006

BASI:
laminato Cappuccino venato

SPECCHIO:
contenitore battente

UNICOLOR:
Marrone Wraki

LAMPADA:
mod. SIGARO alogena

TOP:
EKO sp.1,2 con vasca integrata

LAVATOIO:
integrato

MANIGLIE:
mod. S1 cromata

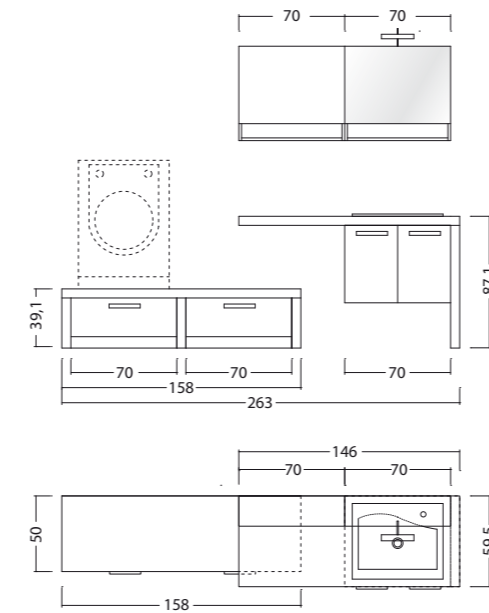

Comp. SML-04 - pag. 032

BASI:
G110 Gianduia opaco

SPECCHIO:
mod. KRABI con vano a giorno

TOP UNICOLOR:
Luna sp.6

LAMPADA:
mod. SIGARO alogena

MANIGLIE:
mod. S2 bianca

LAVATOIO:
vasca soprapiano 60x50

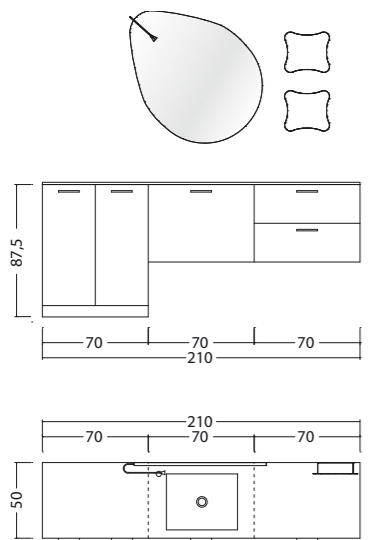

Comp. SML-02 - pag. 014

BASI:
G075 Grigio Caldo opaco

SPECCHIO:
mod. GOCCIA retroilluminato led

PENSILI ALISEO:
metallo verniciato Bianco

LAMPADA:
mod. STYLE led

TOP:
EKO sp.1,2 con vasca integrata

LAVATOIO:
integrato

MANIGLIE:
mod. N1 cromata

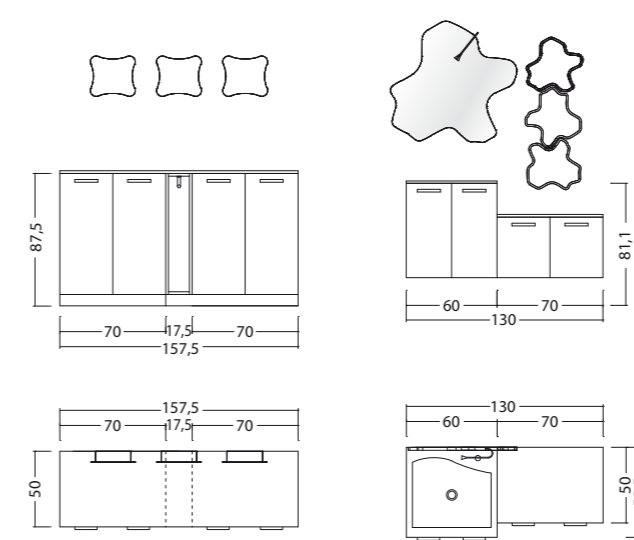

Comp. SMV-05 - pag. 042

BASI:
H650 Cobalto opaco su venato

SPECCHIO:
mod. AMEBA

PENSILI AMEBA:
H650 Cobalto opaco su venato

LAMPADA:
mod. STYLE led

PENSILI ALISEO:
metallo verniciato Bianco

LAVATOIO:
vasca soprapiano 60x60

TOP:
laminato Bianco

MANIGLIE:
mod. ARCO cromata

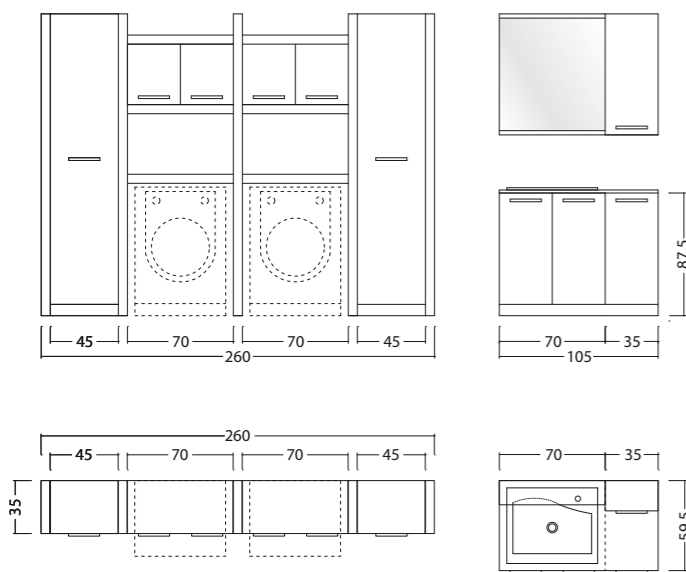

Comp. SMC-03 - pag. 024

BASI:
laminato Bianco venato

SPECCHIO:
sospeso

UNICOLOR:
Porfido Gesso

LAMPADA:
faretto alogeni

TOP:
marmo tecnico sp.2
Bianco Aosta

LAVATOIO:
vasca soprapiano 60x50

MANIGLIE:
mod. K1 cromata

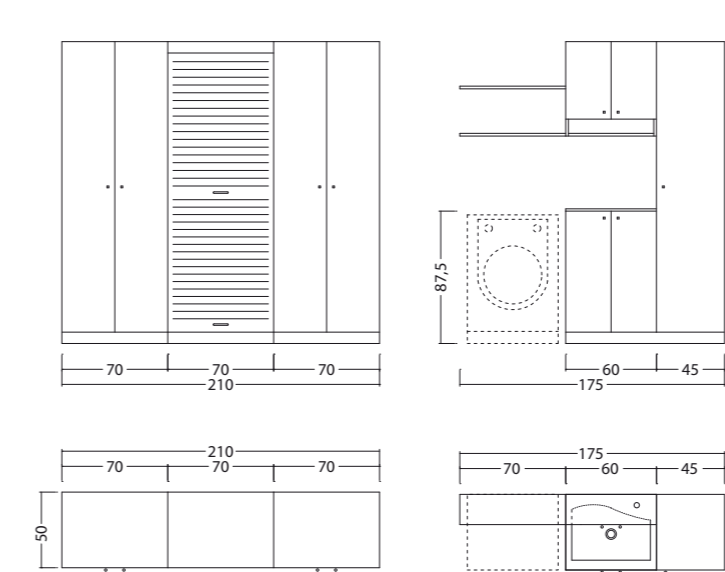

Comp. SMC-06 - pag. 050

BASI:
laminato Swedish Cotton

LAVATOIO:
vasca soprapiano 60x50

MANIGLIE:
pomolo CLIO alluminio

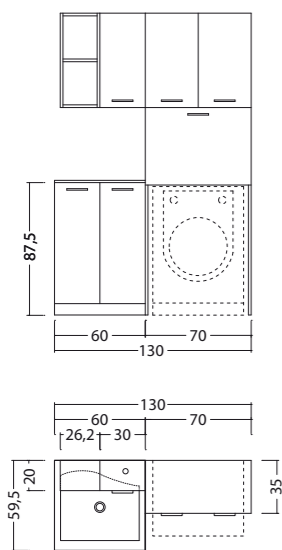

Comp. SMC-07

pag. 058

BASI:
laminato Greystone

LAVATOIO:
vasca soprapiano 60x60

MANIGLIE:
mod. N1 cromata

Comp. SMC-10

pag. 078

BASI:
Struttura: Corda venato
Frontali: laminato Bianco

SPECCHIO:
appoggio

TOP:
EKO sp.1,2 con vasca integrata

LAMPADA:
faretti alogeni

MANIGLIE:
mod. N1 cromata

LAVATOIO:
integrato

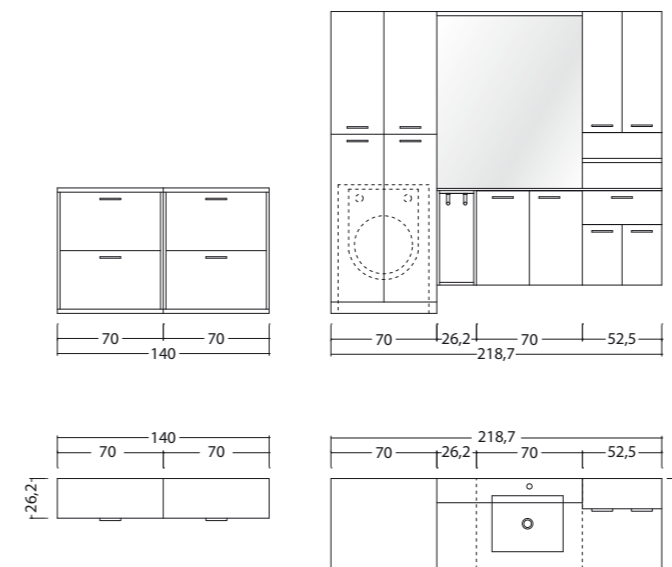

Comp. SMC-08

pag. 064

BASI:
laminato Cappuccino venato

SPECCHIO:
sospeso

TOP:
laminato Cappuccino venato

LAMPADA:
faretti alogeni

MANIGLIE:
pomolo CLIO alluminio

LAVATOIO:
vasca soprapiano 60x50

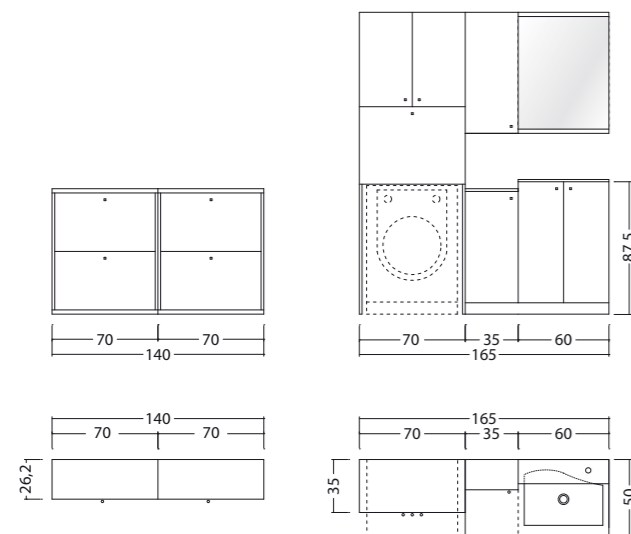

Comp. SMF-11

pag. 084

BASI:
laccato Bianco lucido

SPECCHIO:
mod. KRABI con vano a giorno

UNICOLOR:
Graffite

LAVATOIO:
integrato

TOP:
EKO sp.1,2 con vasca integrata

MANIGLIE:
mod. K3 titanio

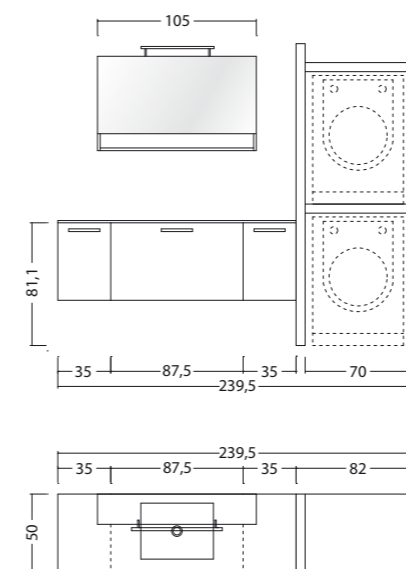

Comp. SMF-09

pag. 070

BASI:
laccato Bianco opaco

SPECCHIO:
mod. GOCCIA retroilluminato led

VANI A GIORNO:
G585 Verde Mare opaco

LAMPADA:
mod. STYLE led

TOP:
EKO sp.1,2 con vasca integrata

LAVATOIO:
integrato

MANIGLIE:
mod. CLIO alluminio

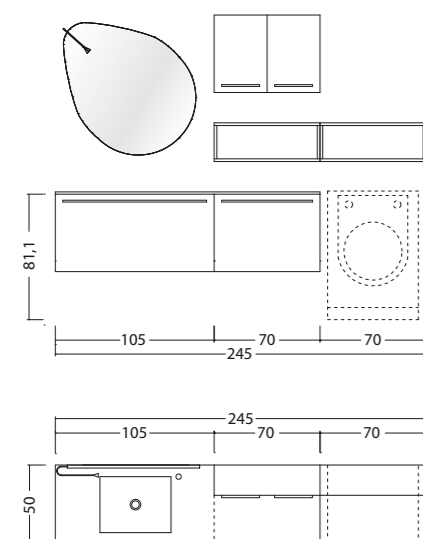

Comp. SMC-12

pag. 090

BASI:
Corda venato

SPECCHIO:
sospeso

PENSILI ALISEO:
metallo verniciato Bianco

LAMPADA:
faretti alogeni

TOP:
Corda venato

LAVATOIO:
vasca soprapiano 60x60

MANIGLIE:
pomolo MOODY cromato

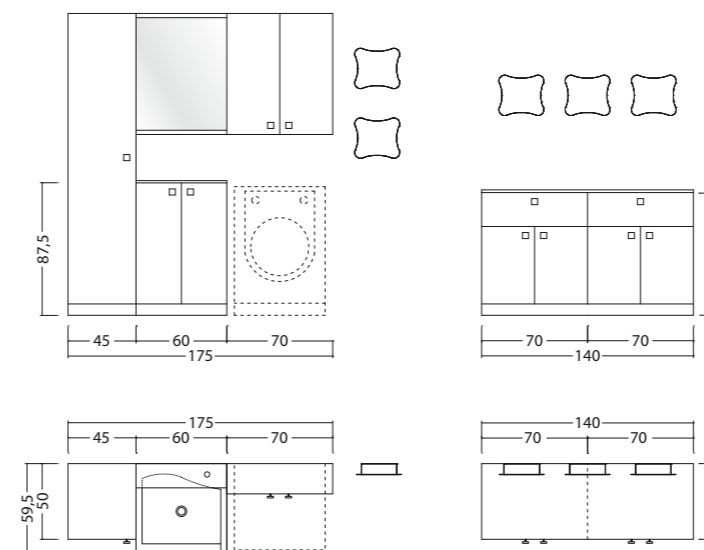

Comp. SMC-13

pag. 098

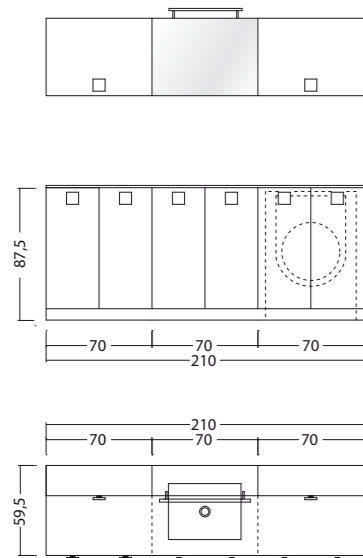

BASI:
laminato Greystone

TOP:
EKO sp.1,2 con vasca integrata

MANIGLIE:
pomolo ZEN cromato

SPECCHIO CONTENITORE:
mod. ZIPPO

LAMPADA:
mod. RIGA led

LAVATOIO:
integrato

Comp. SMC-16

pag. 116

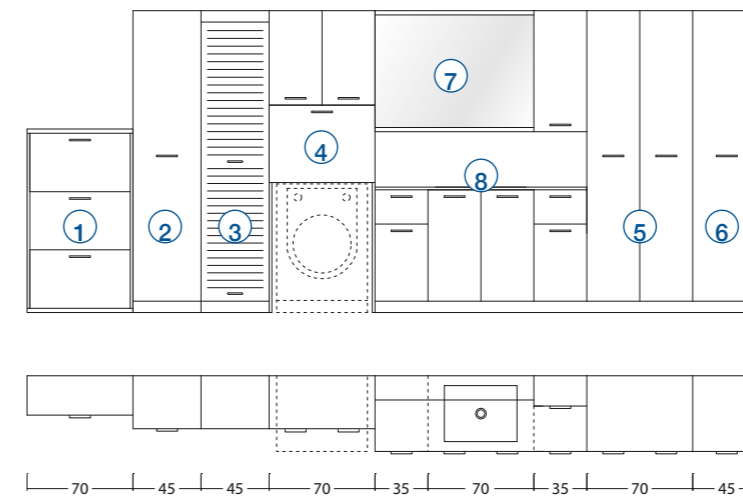

- ① scarpiera 3 ante ribalta
- ② colonna attrezzata - stiro
- ③ contenitore multiuso a serrandina
- ④ colonna attrezzata - portabiancheria con vano lavatrice
- ⑤ colonna attrezzata - portascope
- ⑥ colonna attrezzata - con cesti portabiancheria
- ⑦ specchio SOSPESO con faretti alogeni, presa e interruttore
- ⑧ piano lavatoio EKO sp.1,2 con vasca integrata

Comp. SMZ-14

pag. 106

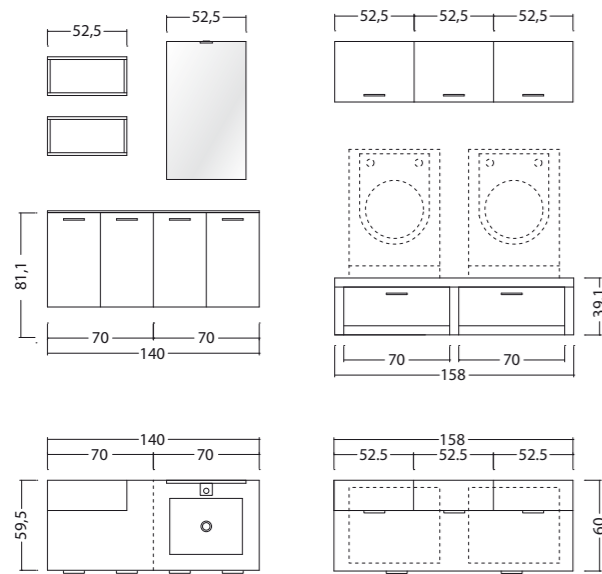

BASI:
Struttura: K095 Nero Intenso lucido
Frontali: K570 Verde Muschio lucido

VANI A GIORNO:
K095 Nero Intenso lucido

UNICOLOR:
Nero Climb

TOP:
EKO sp.1,2 con vasca integrata

MANIGLIE:
mod. N1 cromata

SPECCHIO:
mod. SQUARE

LAMPADA:
mod. CLUB led

LAVATOIO:
integrato

Comp. SMC-15

pag. 112

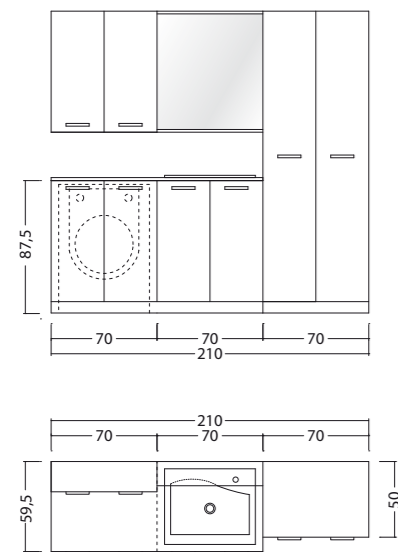

BASI:
laminato Swedish Cotton

TOP:
marmo tecnico sp.2
Bianco Aosta

MANIGLIE:
mod. ARCO cromata

SPECCHIO:
sospeso

LAMPADA:
faretti alogeni

LAVATOIO:
vasca soprapiano 60x50

Comp. SMC-17 pag. 121

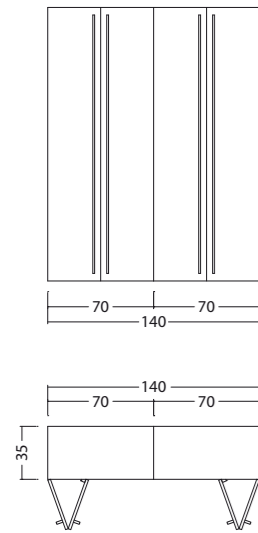

COLONNE PORTABITI:
laminato Corda venato

MANIGLIE:
mod. CLIO alluminio

Comp. SMC-20 pag. 129

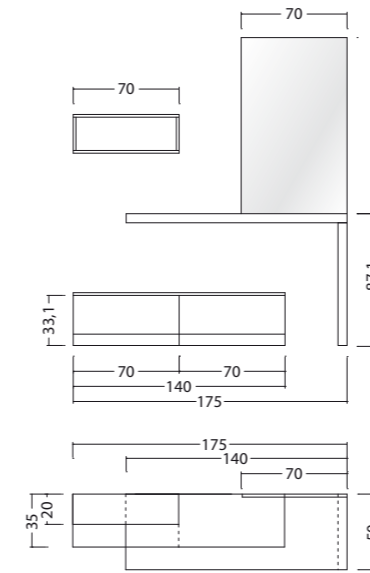

BASI:
laminato Greystone

MANIGLIE:
mod. PUSH-PULL

VANO A GIORNO:
K090 Antracite lucido

SPECCHIO:
appoggio

TOP UNICOLOR:
Luna sp.6

Comp. SMC-18 pag. 123

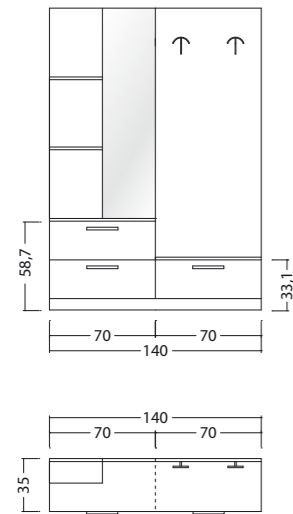

BASI:
laminato Bianco venato

MANIGLIE:
mod. K1 cromata

TOP:
laminato Bianco venato

PANNELLI ATTREZZATI:
laminato Bianco venato

Comp. SMC-21 pag. 131

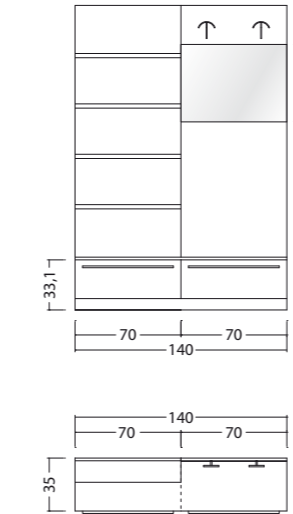

BASI:
tranché Avena spazzolato

MANIGLIE:
mod. CLIO alluminio

TOP:
tranché Avena spazzolato

PANNELLO ATTREZZATO:
tranché Avena spazzolato

MENSOLE:
K015 Panna lucido

Comp. SMC-19 pag. 125

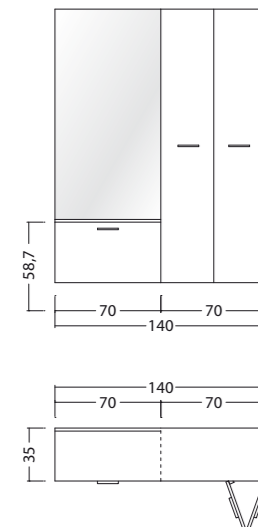

BASI:
laminato Cappuccino venato

MANIGLIE:
mod. N1 cromata

TOP:
laminato Cappuccino venato

COLONNA PORTABITI:
laminato Cappuccino venato

PANNELLO ATTREZZATO:
specchiera

Comp. SMZ-22 pag. 133

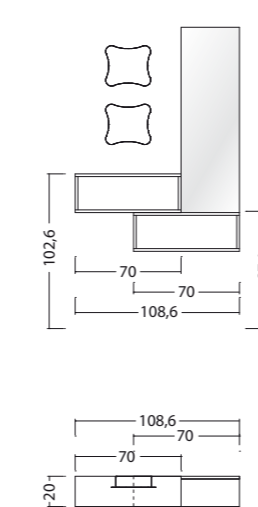

VANI A GIORNO:
K060 Grigio Malta lucido

SPECCHIO:
mod. STREAM

PENSILI ALISEO:
metallo verniciato Bianco

Comp. SMC-23

pag. 137

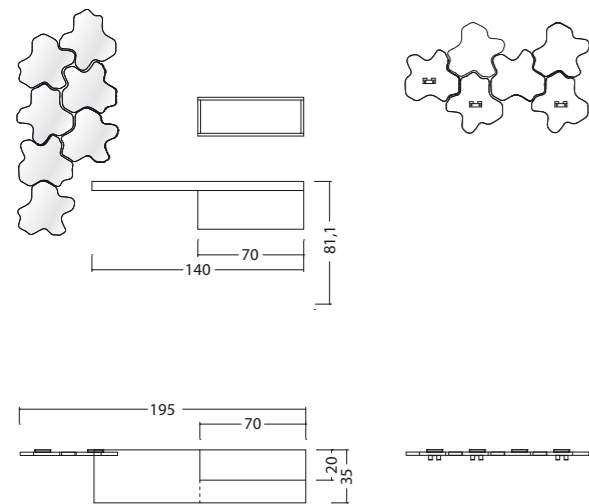

BASI:
tranché Cacao spazzolato

VANO A GIORNO:
tranché Cacao spazzolato

TOP UNICOLOR:
Porfido Gesso sp.6

PENSILI AMEBA:
G585 Verde Mare opaco
G720 Glicine opaco
G730 Lilla opaco

MANIGLIE:
mod. PUSH-PULL

SPECCHI:
pannelli AMEBA retroilluminati led

Comp. SMC-26

pag. 143

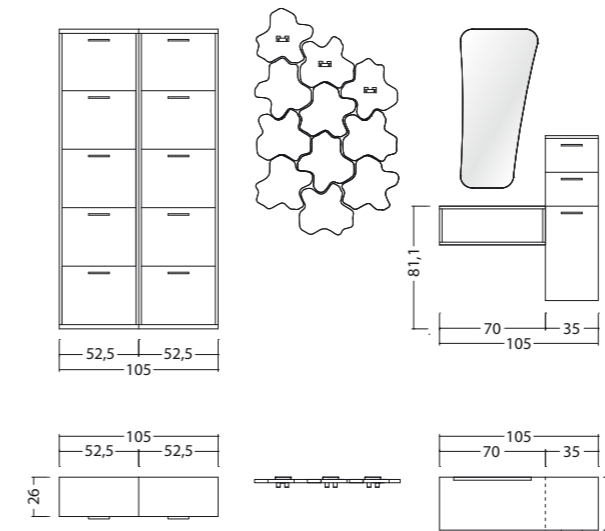

BASI:
laminato Swedish Cotton

VANO A GIORNO:
laccato Bianco lucido

TOP:
laminato Swedish Cotton

PENSILI AMEBA:
G005 Bianco opaco
G720 Glicine opaco
G730 Lilla opaco

MANIGLIE:
mod. N1 cromata

SPECCHIO:
mod. DROP retroilluminato led

SCARPIERE:
laminato Swedish Cotton

Comp. SMC-24

pag. 139

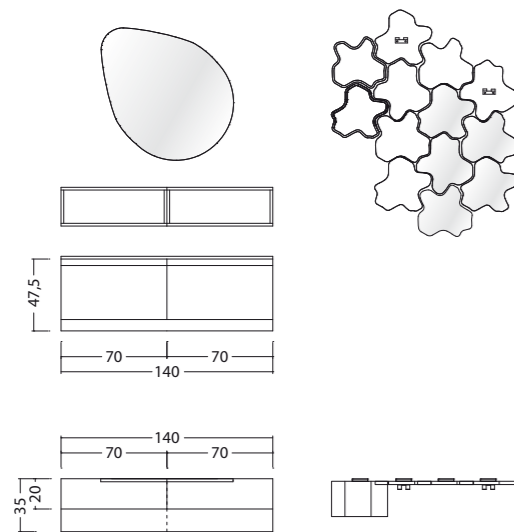

BASI:
laminato Swedish Cotton

VANI A GIORNO:
K060 Grigio Malta lucido

TOP:
laminato Swedish Cotton

PENSILI AMEBA:
G005 Bianco opaco
G585 Verde Mare opaco
G730 Lilla opaco

MANIGLIE:
mod. STEP brill

SPECCHIO:
mod. GOCCIA retroilluminato led

Comp. SMF-25

pag. 141

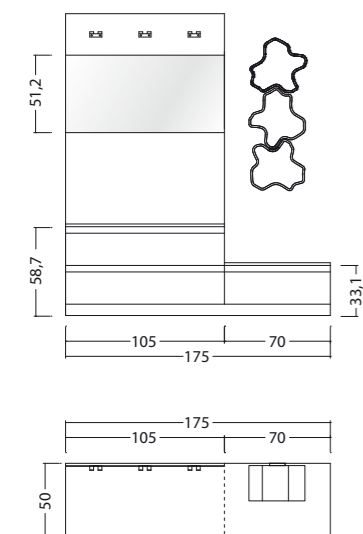

BASI:
laccato Bianco lucido

TOP:
laminato Bianco lucido

PANNELLO ATTREZZATO:
laccato Bianco lucido

MANIGLIE:
mod. INCLUDE

PENSILI AMEBA:
K090 Antracite lucido

Una soluzione completa per ogni esigenza. Ci proponiamo al grande pubblico come un'azienda "di servizio" assistendo i nostri clienti fin dalle prime fasi di progettazione, studio e preventivo. Mettiamo la nostra esperienza al VOSTRO servizio rinnovando l'impegno di fare dei nostri arredi una realtà da vivere tutti i giorni. Synergie produce arredi per il bagno moderno con particolare attenzione alla scelta dei materiali e alla cura delle lavorazioni. Una grande libertà compositiva, che consente di spaziare dal mobile "per tutti i giorni" fino alle più complesse realizzazioni, caratterizza la produzione dell'azienda. Synergie nasce nel 1997 e fa parte del Gruppo Corazzin, fondato nel 1971 e situato nel Nord-Est Italia, una realtà comprendente 10 stabilimenti produttivi con distinti marchi aziendali ed una sede commerciale dove risiede l'area espositiva e il commerciale estero. L'oggetto della produzione, da un punto di vista globale, è il mobile d'arredamento: la tipologia produttiva delle aziende si sviluppa, infatti, attraverso l'intera gamma dei mobili per la casa: cucine, soggiorni, camere, arredo-bagno, camerette, imbottiti ed uffici. Complessivamente il Gruppo Corazzin copre un'area di ben 360.000 mq, considerando le sedi produttive e direzionali.



Synergie s.r.l.
Via Fossa, 11
31051 Follina (TV)
Tel. +39 0438 970995
Fax. +39 0438 970984
www.synergie-bagni.it
synergie@synergie-bagni.it

The Synergie logo, consisting of a stylized blue 'S' followed by the word "Synergie" in a serif font.
ARREDARE IL BAGNO

